



VA250.1 : Valve actuator

For controllers with continuous output (0...10V) or switched output (2- or 3-point control). To operate through valves or three-way valves in series Comar line. Choice of characteristic (linear/equal-percentage) can be set on the actuator.

Two-part housing of fire-retardant plastic, lower part in black, upper part in green. With stepping motor, SUT electronic control unit and maintenance-free gears. Fixing bracket of plastic and cap nut of brass for fitting the valve. Assembly with the valve is practically automatic. Direction of operation can be changed at the cable. Electronic, torque-based cut-out via stops on either the actuator or the valve; automatic adaptation to the valve's stroke. Coding switches for selecting characteristic and running time. Disengageable gears for positioning the valve by hand (Allen key enclosed with product). Power cable 1.2 m long, 5 × 0.5 mm². Fitting position: anywhere from vertical to horizontal, but not upside down.

Type	Running time [s]	Stroke ⁵⁾ [mm]	Pushing force [N]	Power	Weight [kg]
For valves with linear characteristic, can be switched over to equal-percentage					
VA250.1	35/65/130	7.5	250	24 V~	0.7
Positioner ¹⁾					
Control signal	0...10V, R _i > 100 kΩ		Starting point U ₀	0 or 10V	
Positional feedback signal	0...10V, load > 10 kΩ		Control span ΔU	10V	
			Switching range X _{sh}	200 mV	
Power supply	24V~ ± 20%, 50...60 Hz		Protection (horizontal)	IP 54 as per EN 60529	
	24V= ²⁾ + 20% / - 10%		Protection class	III as per IEC 60730	
Power consumption			Response time ¹⁾	200 ms	
VA250.1	4.8 W	8.5 VA			
VA250.1	4.9 W	8.7 VA			
Max. media temperature	100 °C				
Permissible amb. temp.	-10...55 °C				
Ambient humidity	5...95 %rh without condensation				

Deviation from standard type: inverse scale therefore inverse direction of operation. Adaptor for control valve available on the valve. or from TA-Regulator. stating reference no. 52 757 003.

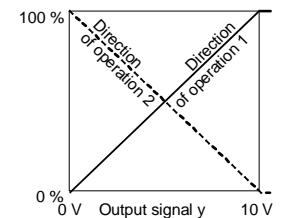

- 1) Also for 2-point or 3-point. depending on type of connection
- 2) 24V = for input signal of 0...10V , VA250.1 for all functions.
- 3) Fully variable from 0...100%; max. loading 5 (2) A. 24...230V
- 4) Only one potentiometer or one set of auxiliary contacts can be fitted to each drive!
- 5) Maximum stroke of drive = 10.0 mm

Operation

Depending on how it is connected (see wiring diagram), the actuator can be used as a continuous 0...10V, as a 2-point (open/close) or as a 3-point drive (open/stop/close) with intermediate position. The running time can be matched to requirements using switches S1 and S2. The characteristic (equal-percentage or linear) can be selected with switch S3. The VA250.1 is combined with valves that have a linear basic characteristic such as the Comar Line valves. The VA250.1 is combined with valves that have an equal-percentage basic characteristic such as Comar Line valves. The VA250.2 can be fitted on a valve with a linear characteristic, but you must pay attention to the position of the coding switches. With the VA250.1, it is not possible to create an equal-percentage characteristic for a valve with a linear characteristic.

Manual adjustment is performed by disengaging the gears (sliding switch next to the power cable) and simultaneously turning, using an Allen key in the insert on the upper part of the drive. Eight mm of stroke is attained with 1½ turns.

N.B.: After manual adjustment, re-set the sliding switch (engage the gears).

Connected as a 2-point actuator

Open/close activation can be effected via two wires. Power is applied to the drive via the blue and the brown wires. On connecting power to the black wire, the valve's control passage opens. When power is switched off, the drive goes to the opposite end position and closes the valve.

The unused red and grey wires should not be connected, nor should they come into contact with other wires. We recommend that you insulate them.

Connected as a 3-point control unit

By connecting power to the wires (brown or black), the valve can be moved to any position. The coupling rod extends and opens the valve if power is applied to the black wire. It retracts and closes the valve if power is applied to the blue and the brown wires.

In the end positions (on hitting a stop in the valve or reaching the maximum stroke) or in the event of an overload, the electronic motor cut-off responds (no end switches). The direction of the stroke can be changed by swapping the power-supply wires over (BN/BK). The unused red and grey wires should not be connected, nor should they come into contact with other wires. We recommend that you insulate them.

Connections for control voltage 0...10V

The integrated positioner controls the drive as a function of the controller's positioning signal y.

Direction of operation 1 (mains power on brown wire): the coupling rod extends and opens the valve (control passage) as the positioning signal rises.

Direction of operation 2 (mains power on black wire): the coupling rod retracts and closes the valve (control passage) as the positioning signal rises.

The starting point and the control span are both permanently set. There is a split-range unit available (as an accessory) for setting partial ranges.

After manual adjustment or in the event of a power failure for longer than 5 minutes, the drive re-adjusts itself automatically, always with a running time of:

VA250.1 60 s







After power has been applied, the stepping motor moves to the lower stop, connects to the valve spindle and moves to the upper stop in the valve, thereby determining the closed position. Depending on the control voltage, any stroke between 0 and 8 mm can then be obtained. Thanks to the electronics unit, no steps can be lost, and the drive needs no periodical re-adjustment. Parallel operation of more than one drive of the same type is guaranteed.

The feedback signal $y_0 = 0...10V$ corresponds to the effective stroke of 0 to 8 mm.







If the control signal (0...10V) is interrupted and direction of operation 1 is connected, the valve closes fully (0% position).

The valve's characteristic can be selected using the coding switch. The characteristics can be generated only if the drive is used as a continuous drive. Other switches enable the running times to be set. These can be applied irrespective of whether the 2-point, 3-point or the continuous function has been chosen.

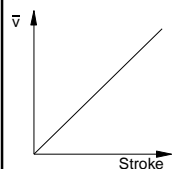
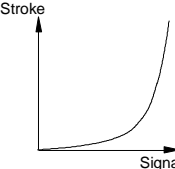
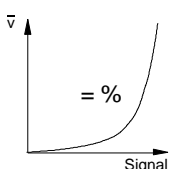
Coding switch for running time selection

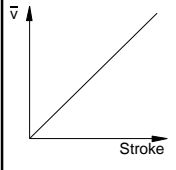
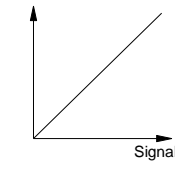
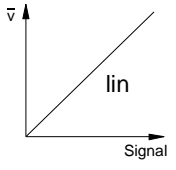
Run time per mm	Switch coding	Run time for 8 mm stroke
4,375 s	<div style="display: flex; justify-content: space-around;"> 123 </div>  <div style="display: flex; justify-content: space-between; margin-left: 10px;"> On Off </div>	35 s ± 1
8,125 s	<div style="display: flex; justify-content: space-around;"> 123 </div>  <div style="display: flex; justify-content: space-between; margin-left: 10px;"> On Off </div>	65 s ± 2
16,25 s	<div style="display: flex; justify-content: space-around;"> 123 </div>  <div style="display: flex; justify-content: space-between; margin-left: 10px;"> On Off </div>  <div style="display: flex; justify-content: space-around;"> 123 </div>  <div style="display: flex; justify-content: space-between; margin-left: 10px;"> On Off </div>	130 s ± 4
 = factory setting		

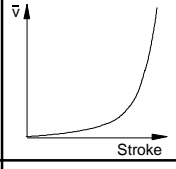
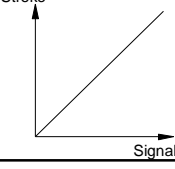
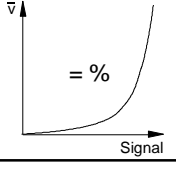
Coding switch for characteristics selection

Desired character. curve	Switch coding	Characteristic curve for valve	Characteristic curve for drive	Effective on valve
Equal percentage	<div style="display: flex; justify-content: space-around;"> 123 </div>  <div style="display: flex; justify-content: space-between; margin-left: 10px;"> On Off </div>			
Linear	<div style="display: flex; justify-content: space-around;"> 123 </div>  <div style="display: flex; justify-content: space-between; margin-left: 10px;"> On Off </div>			
Equal percentage	<div style="display: flex; justify-content: space-around;"> 123 </div>  <div style="display: flex; justify-content: space-between; margin-left: 10px;"> On Off </div> 			
 = factory setting				

Engineering and fitting notes

The ingress of condensate, drops of water etc. along the valve spindle and into the drive should be prevented.

With the electrical connection, you must also make sure that the cross-section of the supply line is adapted to the power and length. In any case, however, we recommend that the cross-section should not be less than a minimum of 0.75 mm².

The assembly of drive and valve is done by fitting and tightening the cap nut without further adjustment; no tools should be used. The valve spindle and the drive spindle are coupled together automatically, either by using the manual adjustment facility or by applying power. When dismantling, first release the drive/valve spindle, then loosen the cap nut.

The drive is supplied ex works in the middle position.

The combination of stepping motor and electronics allows several actuators of the same SUT type to be run in parallel.

The following accessories can be fitted to each actuator: one set of auxiliary contacts.

The coding switches are accessible via an opening with black lid in the housing cover.

The auxiliary contacts should be screwed onto the drive's top cover. Before the mechanical connection can be established, the indicator knob should be removed. A new indicator is then visible on the lid of the auxiliary contacts.

N.B.: The housing should not be opened.

Fitting outdoors. If the devices are fitted outdoors, we recommend that additional measures be taken to protect them against the effects of the weather.

Additional technical data

The upper part of the housing, with the lid, indicator knob and the cap, contains the stepping motor and the SUT electronic control unit. The lower part contains the maintenance-free gears.

Auxiliary change-over contacts

Switch rating: max. 230V a.c.; min. current 20 mA at 20V

Switch rating: max. 4...30V d.c.; current 1...100 mA

Power consumption:

Type	Running time s	Condition	active power P W	apparent power S VA
VA250.1	35	Operating	2.45	4.75
		Standstill	0.35	0.8
	60	Operating	4.8	8.5
		Standstill	0.35	0.8
	120	Operating	2.2	4.25
		Standstill	0.35	0.8

CE conformity

EMC directive 89/336/EEC

EN 61000-6-1

EN 61000-6-3

EN 61000-6-4

Machine directive 98/37/EEC (II B)

EN 1050

Wiring diagram

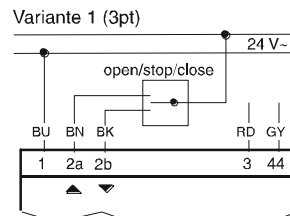
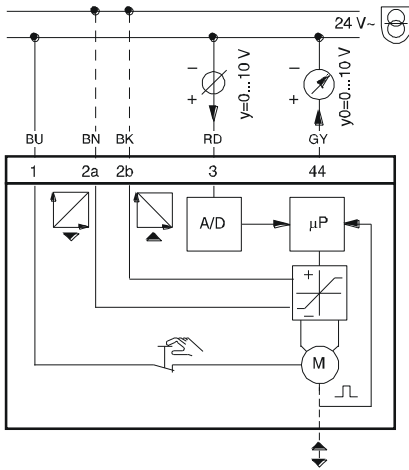

RD = red
 BN = brown
 BK = black
 BU = blue
 GY = grey

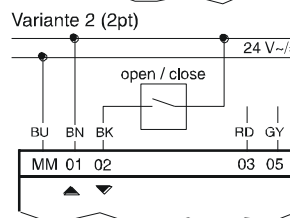
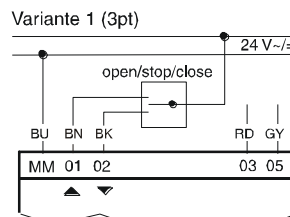
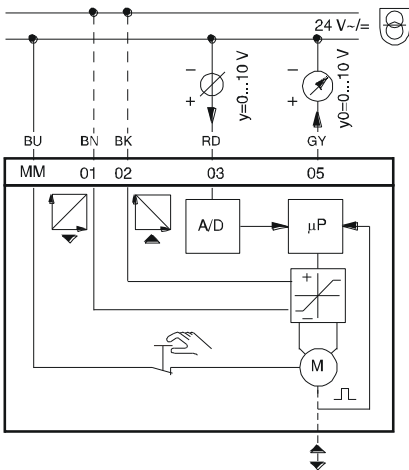
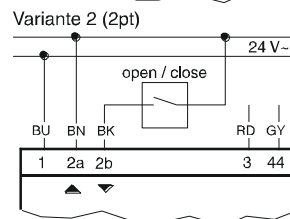

Dimension drawing

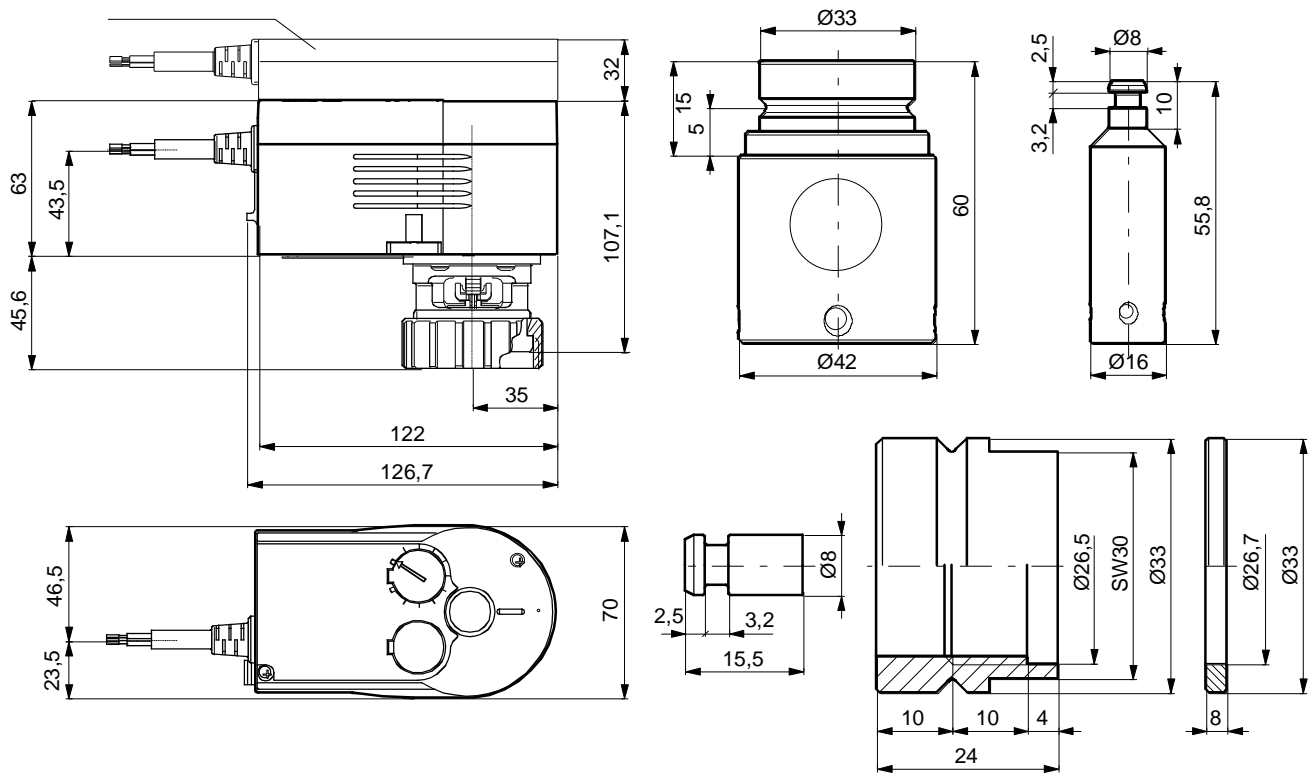

Accessories

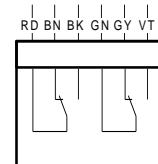
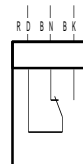
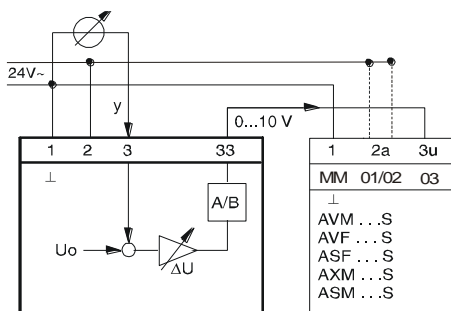

1	2a	3u
MM	01/02	03
⊥		
AVM ... S		
AVF ... S		
ASF ... S		
AXM ... S		
ASM ... S		